

UB4770 Performance Specifications

LF Components	2226H (2)
HF Components	2446J w/ 2380A
Sensitivity	100 dB SPL
Power Handling	1200 W LF, 150 W HF
Max Peak SPL	137 dB
Frequency Response	40 - 18k Hz

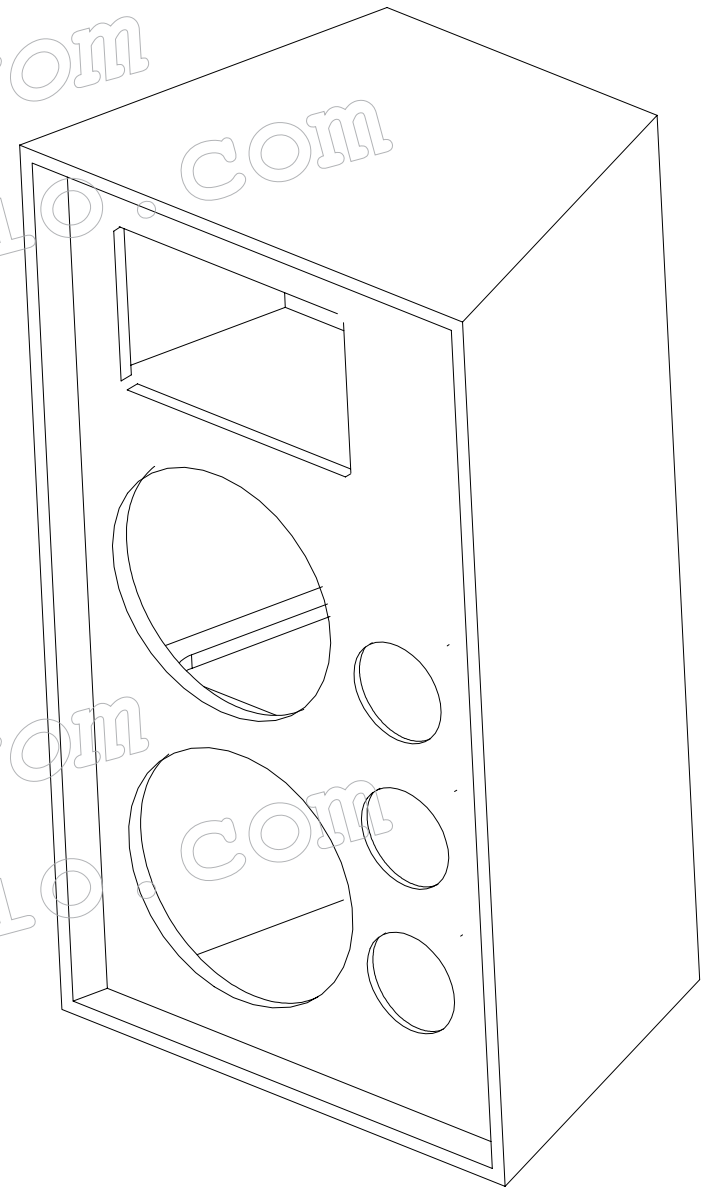

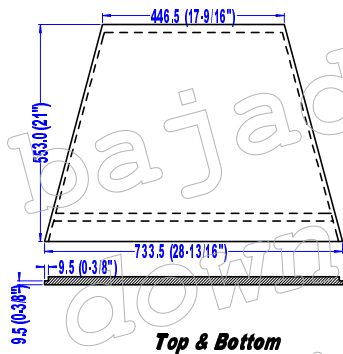

Top & Bottom

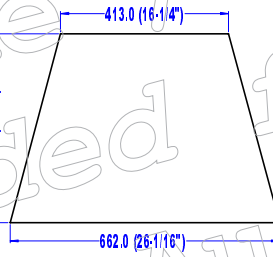

Top Divider

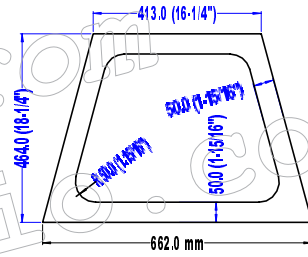

Lower Internal Support

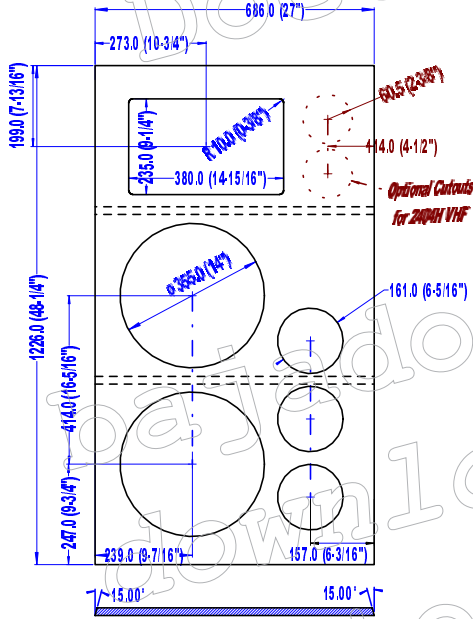

Baffle

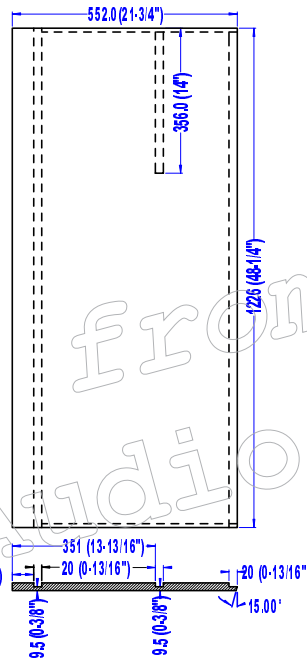
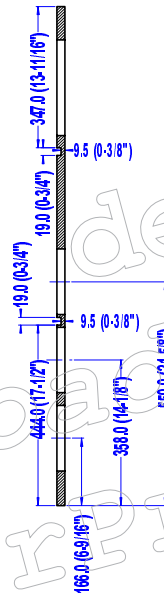

Sides

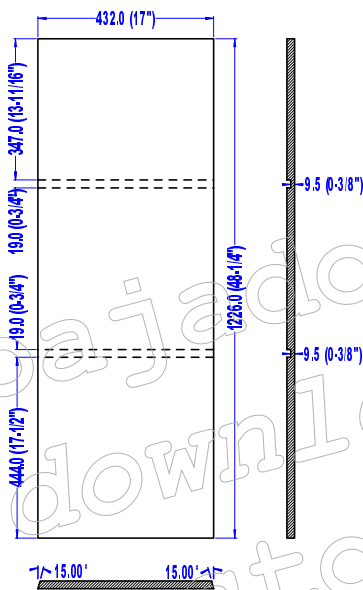

Back

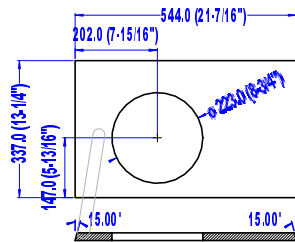

Compression Driver Support

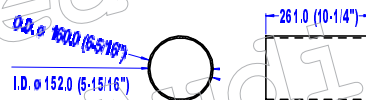

Duct Tubes

***Note:**
 Dimensions are shown as: mm (inches)
 All dimensions are based on metric measurements.
 Some dimensions may need slight adjustment if
 measured in inches.

Xover Freq:
 LF/HF 800 Hz
 HF/VHF 7kHz

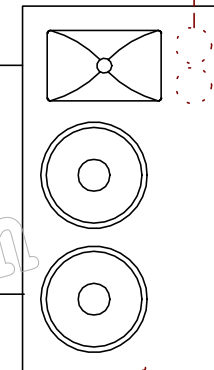
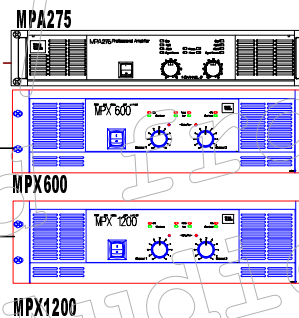
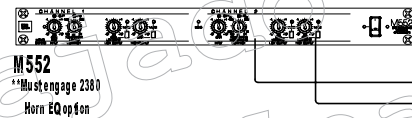

UB4770 w/o Network

UB4770 Active 2 way (3-way optional) Configuration

Xover Freq:
 LF/HF 800 Hz

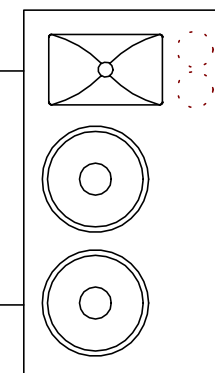
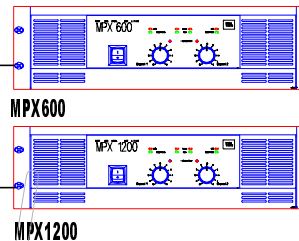
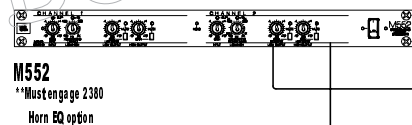

UB4770 with Network
 2404H VHF Network Optional

**UB4770 w/ Passive HF (Optional VHF) Network
 Option 1**

Xover Freq:
 LF/HF 800 Hz

Direct from Mixer

Out from IM-10

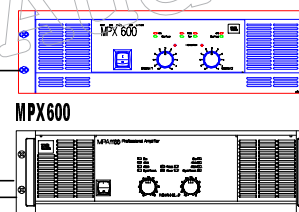

MPA1100 w/ IM-10
 Xover card installed

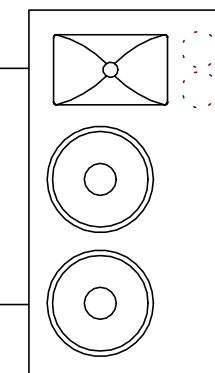

UB4770 with Network
 2404H VHF Network Optional

**UB4770 w/ Passive HF (Optional VHF) Network
 Option 2**

* This option can also be used for Active 2-way operation. IM-10 includes 2380 Horn EQ.